

Copa de Espanya A Junior Ciudad de Valencia 2017

Valencia (ESP), 14 Oct 2017

-55 kg

18 Judoka

POOL A

1	GARCIA MESA, Francisco Jose	AND	1	GARCIA MESA, Francisco Jose
17			17	
9			2	
25			25	
5	GERRA FLORES, Eric	CAT	3	
21	PORRAS FERREIRO, Gaizka	VAL	3	
13			4	
29	RAD GARCIA, Javier	AST	4	RAD GARCIA, Javier

POOL A Winner / Ganador
Vainqueur / Sieger

POOL B

3	GARCIA CHAMIZO, Carlos	EXT	5	GARCIA CHAMIZO, Carlos
19			19	
11			6	
27			27	
7	SENENT SORIANO, Luis	VAL	7	
23	CORRAL GARRIDO, Javier	AST	7	
15	GARCIA DE LA CRUZ LOPEZ, Fernando	MAD	8	
31	RAMIREZ GARCIA, Marc	CAT	8	

POOL B Winner / Ganador
Vainqueur / Sieger

POOL C

2	PEREZ ROLDAN, Javier	AND	9	PEREZ ROLDAN, Javier
18			18	
10			10	
26			26	
6	PALACIOS, Sergio	NAV	11	
22	GARRIDO ROSA, Derek	CAT	11	
14	CABANILLA PRIETO, Alejandro	EXT	12	
30	GARCIA DALMAU, Jordi	VAL	12	

POOL C Winner / Ganador
Vainqueur / Sieger

POOL D

4	GOMEZ LLORENS, Pedro	VAL	13	GOMEZ LLORENS, Pedro
20			20	
12			14	
28			28	
8	GUTIEZ PRIETO, Adrian	AST	15	
24	MUNOZ ALLUE, Jaime	ARA	15	
16	NENNINGER, Valerie Lukas	GER	16	NENNINGER, Valerie Lukas
32			32	

POOL D Winner / Ganador
Vainqueur / Sieger

Trostrunde / Repechage / Ronda de consolación

Repechage

[A1]		29		33
[A2]				
[B1]			[A3]	
[B2]		30		34
			[B3]	
[C1]				
[C2]		31		35
			[C3]	
[D1]				
[D2]		32		36
			[D3]	

1.

43

38

28

27

26

37

25

[38]

3.

Results	
Resultat / Platzierungen / Resultados	
1.	
2.	
3.	
4.	
5.	
6.	
7.	

Copa de Espanya A Junior Ciudad de Valencia 2017

Valencia (ESP), 14 Oct 2017

-60 kg
20 Judoka

POOL A

1	LAINO RAMIREZ, Rosendo	AND	1	LAINO RAMIREZ, Rosendo
17			17	
9			2	
25			25	
5	SENENT SORIANO, Adrian	VAL	3	
21	GOMEZ PERDIGUERO, Ivan	MAD	18	
13	SAGARZAZU BARROSO, Inaki	VAL	4	
29	GARCIA PINTO, Sergio	CLM	4	

POOL A Winner / Ganador
Vainqueur / Sieger

POOL B

3	BLANCO VICENTE, Hector	MAD	5	BLANCO VICENTE, Hector
19			19	
11			6	
27			27	
7	TORO SOLER, Julen	NAV	7	
23	SANTACREU GARCIA, Pau	CAT	20	
15	SIERRA SOLER, Mario	MUR	8	
31	MARTINEZ SORIANO, Arnau	VAL	8	

POOL B Winner / Ganador
Vainqueur / Sieger

POOL C

2	ORDONEZ CANO, Eduardo	AND	9	ORDONEZ CANO, Eduardo
18			21	
10			10	
26			26	
6	CASADO OLAYA, Pau	CAT	11	
22	BEJAR AYLLON, Luis Angel	MAD	22	
14	GOMEZ SANMIGUEL, Mario	VAL	12	
30	PLAZA PEGUEROLES, Guillermd	MUR	12	

POOL C Winner / Ganador
Vainqueur / Sieger

POOL D

4	CORTIGLIA MARSICANO, Agustí	CAN	13	CORTIGLIA MARSICANO, Agustin
20			23	
12			14	
28			28	
8	GALINDO MUINOS, Ivan	VAL	15	
24	CANTANO GOMEZ, Roger	CAT	24	
16	IBANEZ BANON, Sergio	ARA	16	
32	BUSTILLO BUSTOS, David	MAD	16	

POOL D Winner / Ganador
Vainqueur / Sieger

1.

43

Results	
Resultat / Platzierungen / Resultados	
1.	
2.	
3.	
5.	
5.	
7.	
7.	

Trostrunde / Repechage / Ronda de consolación

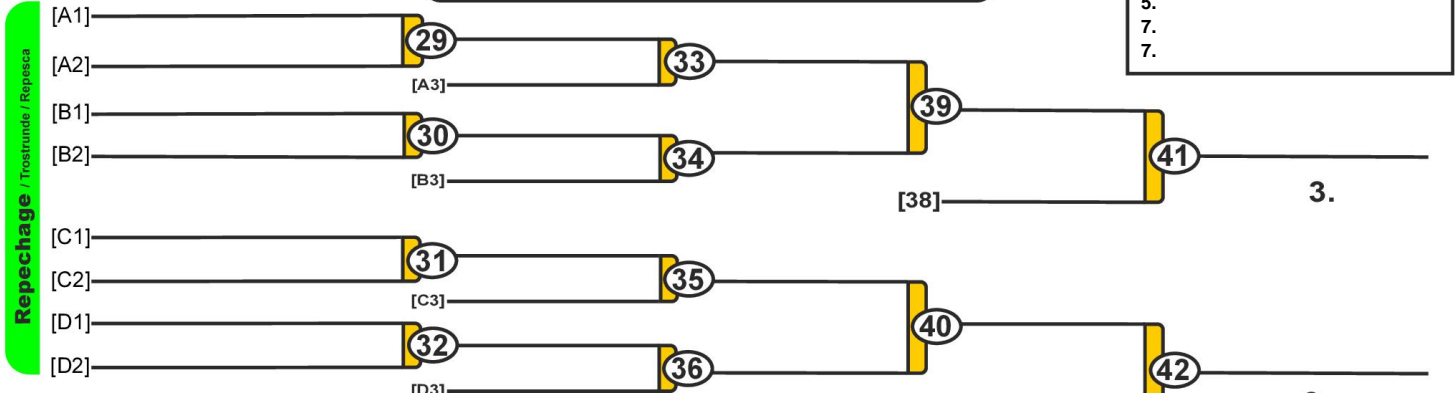

3.

Copa de Espanya A Junior Ciudad de Valencia 2017

Valencia (ESP), 14 Oct 2017

-66 kg

31 Judoka

POOL A

1	CASAS FERNANDEZ, Ricardo	EXT
33		
17		
49		
9		
41	ARES NIETO, Agustin	VAL
25	JIMENEZ RODRIGUEZ, Mario	MAD
57		
5	ROSEMBAUM, Tobias	GER
37		
21	GOMEZ PEREZ, Iker	VAL
53		
13	SEGADO FERNANDEZ, Daniel	MAD
45		
29	SEMPERE GALINDO, Javier	VAL
61		

1	CASAS FERNANDEZ, Ricardo
33	
2	
3	ARES NIETO, Agustin
4	JIMENEZ RODRIGUEZ, Mario
5	ROSEMBAUM, Tobias
6	GOMEZ PEREZ, Iker
7	SEGADO FERNANDEZ, Daniel
8	SEMPERE GALINDO, Javier

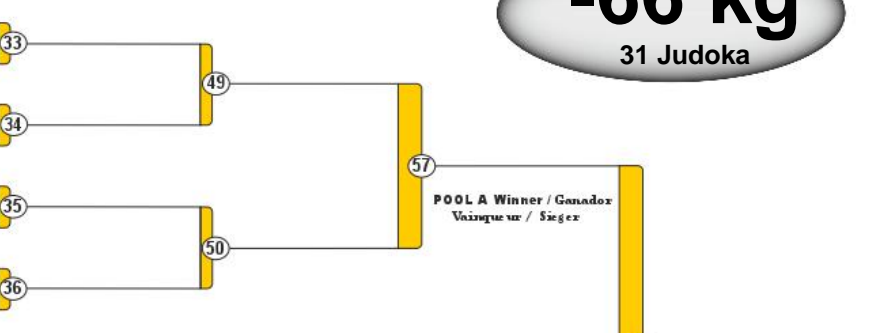

POOL A Winner / Ganador
Vainqueur / Sieger

POOL B

3	PERKAZ ORTIZ, Nestor	NAV
35		
19		
51		
11	CORDOBA GALLEGO, Paco	VAL
43	LOBO PALOMO, Javier	MAD
27	CASTREJON CASTRO, Jesus	CAN
59		
7	BORAU BERNAD, Javier	ARA
39		
23	MORALES LOPEZ, Juan Manuel	AND
55		
15	LOPEZ LOPEZ, Pol	CAT
47		
31	BUENO INFANTES, Carlos	VAL
63		

9	PERKAZ ORTIZ, Nestor
37	
10	
11	
12	CASTREJON CASTRO, Jesus
13	BORAU BERNAD, Javier
14	MORALES LOPEZ, Juan Manuel
15	LOPEZ LOPEZ, Pol
16	BUENO INFANTES, Carlos

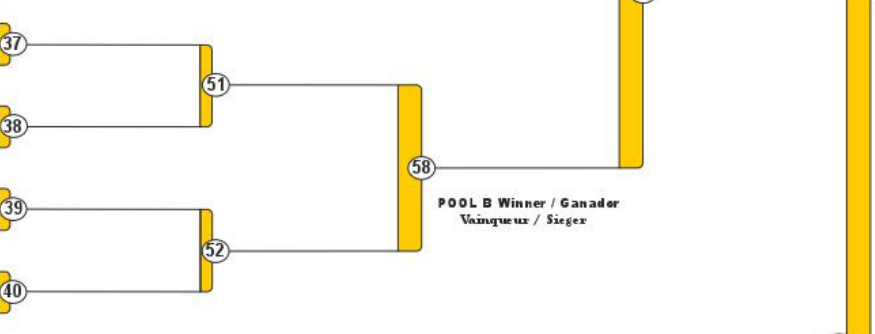

POOL B Winner / Ganador
Vainqueur / Sieger

POOL C

2	ALVAREZ CHULIA, Juan	VAL
34		
18		
50		
10	BARCENA MENDEZ, Sergio	AST
42	ROSAS SOLANO, Eduardo	ARA
26	OTERO SANTAINES, Jose	VAL
58		
6	VAZQUEZ HUERTA, Alejandro	EXT
38		
22	CABEZAS LOPEZ, Pablo	MAD
54		
14	YEDGARIAN, Christian	GER
46		
30	ORTS BUITRAGO, Javier	VAL
62		

17	ALVAREZ CHULIA, Juan
41	
18	
19	
20	OTERO SANTAINES, Jose
21	VAZQUEZ HUERTA, Alejandro
22	CABEZAS LOPEZ, Pablo
23	YEDGARIAN, Christian
24	ORTS BUITRAGO, Javier

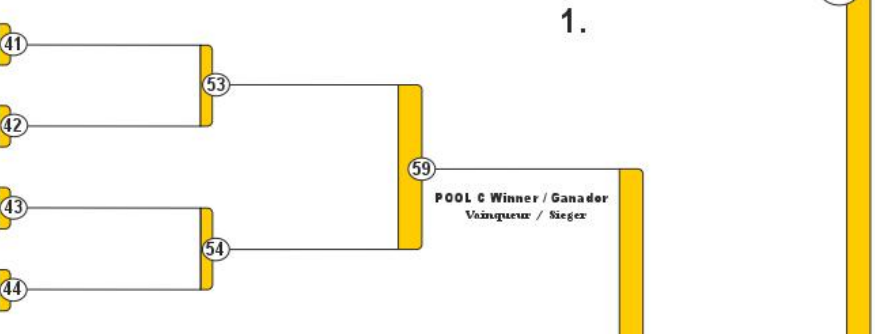

POOL C Winner / Ganador
Vainqueur / Sieger

POOL D

4	LEMONS GONZALEZ, Koldobika	VAS
36		
20		
52		
12	BONCHAK, Anton	NAV
44	SOLIS RISCO, Manuel	MAD
28	SANCHEZ HERNANDEZ, Diego	VAL
60		
8	CALLEJAS SANCHEZ, Juan Jose	AND
40		
24	GARCIA MARXUACH, Noe	MAD
56		
16	LOPEZ DUDAREV, Amos	VAL
48		
32	DENKEWITZ, Florian	GER
64		

25	LEMONS GONZALEZ, Koldobika
45	
26	
27	
28	SANCHEZ HERNANDEZ, Diego
29	CALLEJAS SANCHEZ, Juan Jose
30	GARCIA MARXUACH, Noe
31	LOPEZ DUDAREV, Amos
32	DENKEWITZ, Florian

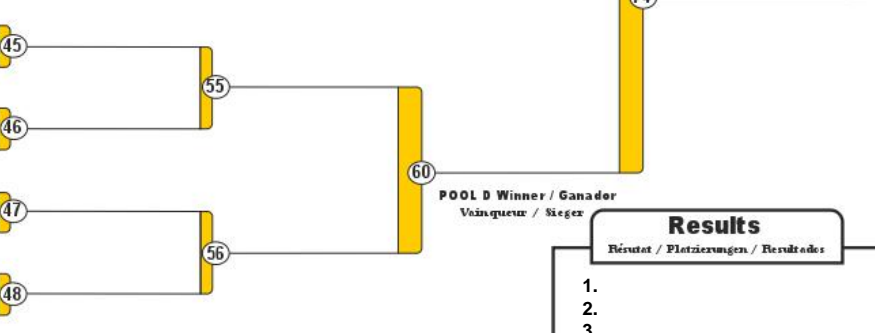

POOL D Winner / Ganador
Vainqueur / Sieger

1.

3.

3.

Results

Résultat / Platzierungen / Resultados

- 1.
- 2.
- 3.
- 3.
- 5.
- 5.
- 7.
- 7.

Trostrunde / Repechage / Ronda de consolación

Repechage

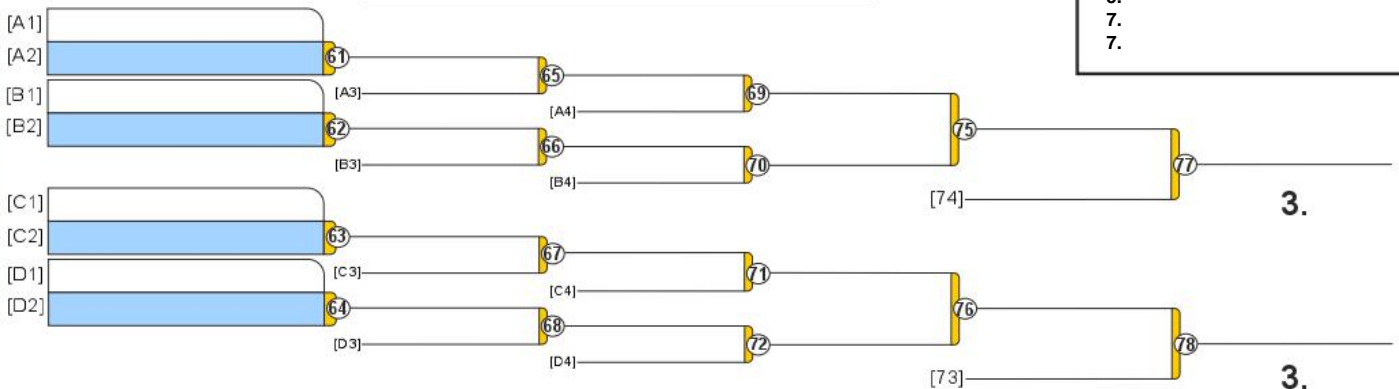

Copa de Espanya A Junior Ciudad de Valencia 2017

Valencia (ESP), 14 Oct 2017

-73 kg

33 Judoka

POOL A

1	NIETO TRINIDAD, Daniel	EXT
33		
17		
49		
9		
41	SANCHIS LAHIGUERA, Pablo	VAL
25	FERNANDEZ RODRIGUEZ, Fernando	MAD
57	CHAVETKTADZE, Nika	CAT
5		
37	AYLLON ORTEGA, Gustavo	MAD
21	PASTOR SEGUI, Aaron	VAL
53		
13	BOLUDA LORENTE, Pablo	VAL
45		
29		
61	GOICOECHEA ALONSO, Aitor	VAS

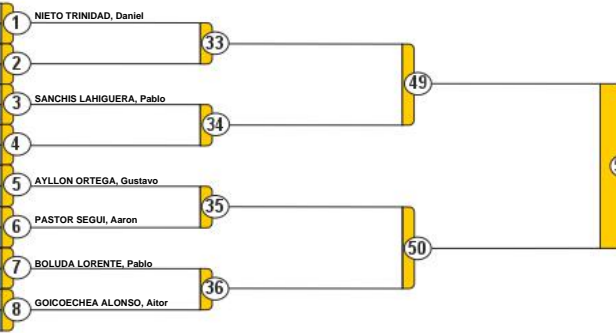

POOL A Winner / Ganador
Vainqueur / Sieger

POOL B

3	CALLEJAS SANCHEZ, Salvador	AND
35		
19		
51		
11	AGRELO FERNANDEZ, Alberto	AST
43	SANZ TORROME, Miguel	VAL
27		
59	VARELA FERRER, Alberto	VAL
7	EGUINO BILBAO, Unai	NAV
39		
23		
55		
15	OLIVAS GREGORIO, Pablo	ARA
47	LOPEZ ATOCHE, Alejandro	MAD
31	GOERNER, Patrick	GER
63	SANCHEZ SEBASTIAN, Javier	VAL

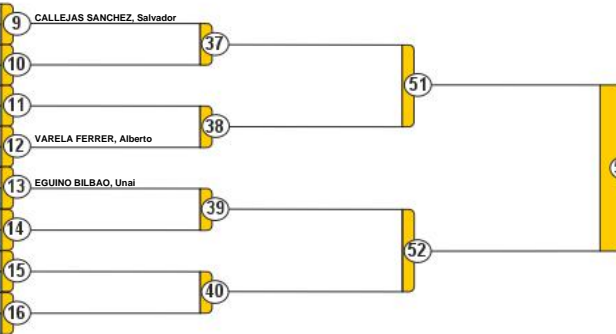

POOL B Winner / Ganador
Vainqueur / Sieger

POOL C

2	CABELLO ORTIZ, Javier	MAD
34		
18		
50		
10	GINER LLORENS, Carlos	VAL
42		
26		
58	MORALES MARTINEZ, Raul	AND
6	MESTRE COTANDA, Josep	VAL
38		
22	URDANGARIN LARRANAGA, Haritz	VAS
54		
14	SARGAY ANGLADA, Artur	CAT
46	VAZQUEZ HUERTA, Roberto	EXT
30	RIVERA BRAU, Enrique	ARA
62		

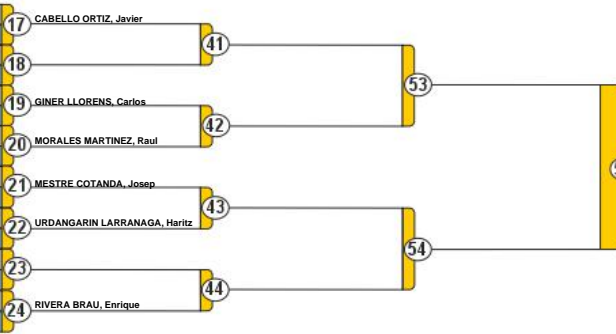

POOL C Winner / Ganador
Vainqueur / Sieger

POOL D

4	FERNANDEZ MORENO, Daniel	MAD
36		
20		
52		
12		
44	MARTIN RINCON, Hernando	VAL
28	KRASIMIROV IVANOV, Miroslav	BUL
60	BELLO PORCAR, Oscar	VAL
8		
40	LUJAN OCHANDO, Hugo	VAL
24		
56	ROMERO LOPEZ, Guillermo	MUR
16	ROMERO GARCIA, Javier	MAD
48		
32	BLANCO BRAVO, Iker	CAT
64		

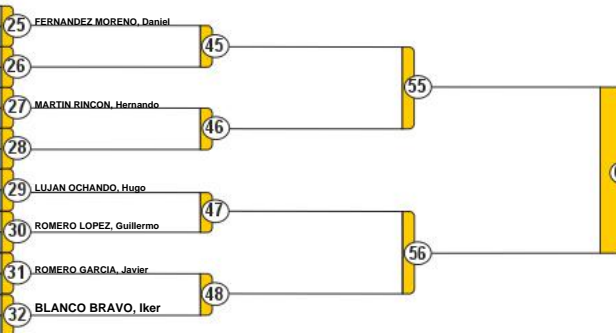

POOL D Winner / Ganador
Vainqueur / Sieger

1.

3.

3.

Trostrunde / Repechage / Ronda de consolación

Repechage

[A1]	
[A2]	
[B1]	
[B2]	
[C1]	
[C2]	
[D1]	
[D2]	

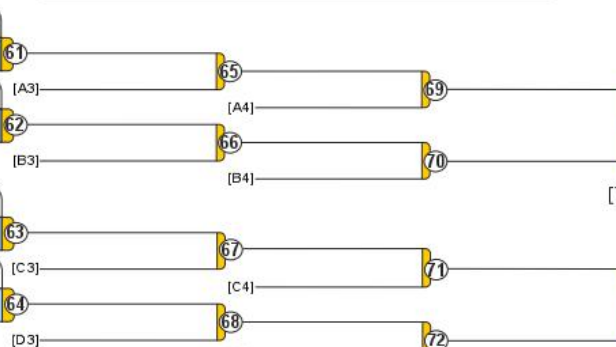

Results
Résultat / Platzierungen / Resultados

- 1.
- 2.
- 3.
- 5.
- 5.
- 7.
- 7.

Copa de Espanya A Junior Ciudad de Valencia 2017

Valencia (ESP), 14 Oct 2017

-81 kg

25 Judoka

POOL A

1	GALLEGO PEREZ-OLIVARES, Javier	MAD
33		
17		
49		
9		
41		
25		
57		
5	TOSCANO, Emanuel	CAT
37		
21	BARCIA BOMHOF, Hugo	VAL
53		
13	TUDELA GARULERA, Joan	CAT
45		
29	GALLEGOS PEREZ, Pablo	AND
61	BRACELI GRANERO, Javier	VAL

1	GALLEGO PEREZ-OLIVARES, Javier	33
2		
3		
4		
5	TOSCANO, Emanuel	35
6	BARCIA BOMHOF, Hugo	50
7	TUDELA GARULERA, Joan	36
8		

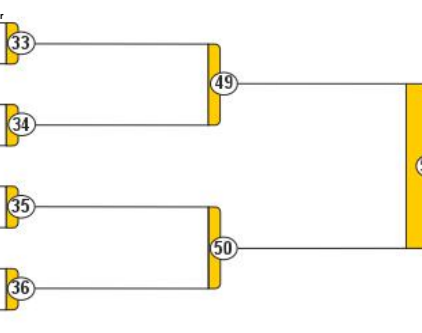

POOL A Winner / Ganador
Vainqueur / Sieger

POOL B

3		
35		
19	GARCIA DOMINGO, Saul	RIO
51		
11	DE LA MUNOZA ROSELLO, Pablo	VAL
43		
27	BARCENA ESPINOSA, Pablo	MAD
59		
7	GARCIA GARMENDIA, Aritz	VAS
39		
23	MENCHACA CABOT, Pol	CAT
55		
15	SEBASTIA VALERO, Hugo	VAL
47		
31		
63		

9	GARCIA DOMINGO, Saul	37
10	GARCIA DOMINGO, Saul	
11	DE LA MUNOZA ROSELLO, Pablo	38
12	BARCENA ESPINOSA, Pablo	39
13	GARCIA GARMENDIA, Aritz	40
14	MENCHACA CABOT, Pol	52
15	SEBASTIA VALERO, Hugo	
16		

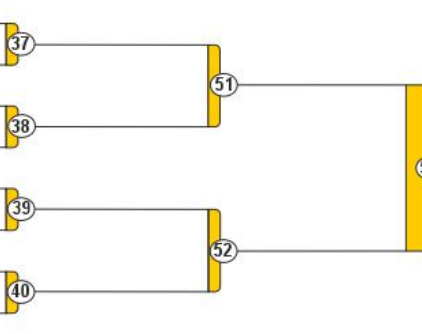

POOL B Winner / Ganador
Vainqueur / Sieger

POOL C

2	ROMERO GUITIERREZ, Daniel	CAT
34		
18		
50		
10		
42		
26		
58		
6	MEROU MESTRE, Joan-Rene	BAL
38		
22	FLORES MARTIN, Jesus Damian	VAL
54		
14	REPARAZ MARTINEZ-BAYARRI, Javier	NAV
46		
30	NIKOLOV, Georgi	VAL
62	RUIZ SEJOO, Josu	VAS

17	ROMERO GUITIERREZ, Daniel	41
18		
19		
20		
21	MEROU MESTRE, Joan-Rene	43
22	FLORES MARTIN, Jesus Damian	54
23	REPARAZ MARTINEZ-BAYARRI, Javier	44
24		

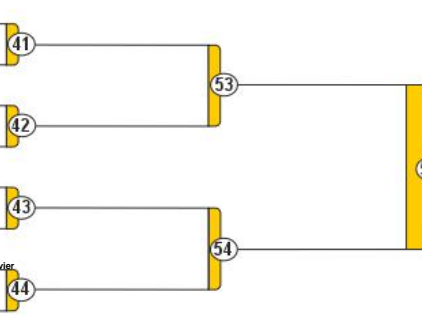

POOL C Winner / Ganador
Vainqueur / Sieger

POOL D

4	FONTANET CLARET, Roger	CAT
36		
20	RIBERA PICO, Joan	VAL
52		
12	DAVILA MONTOYA, Ruben	MAD
44		
28	NOGALES MARTI, Diego	VAL
60		
8	SOLE ALONSO, Jordi	CAT
40		
24		
56		
16	IVANOV, Zdravko	VAL
48		
32	GUZMAN LARA, Eduardo Manuel	DOM
64		

25	FONTANET CLARET, Roger	45
26	RIBERA PICO, Joan	46
27	DAVILA MONTOYA, Ruben	47
28	NOGALES MARTI, Diego	56
29	SOLE ALONSO, Jordi	48
30		
31	IVANOV, Zdravko	
32	GUZMAN LARA, Eduardo Manuel	

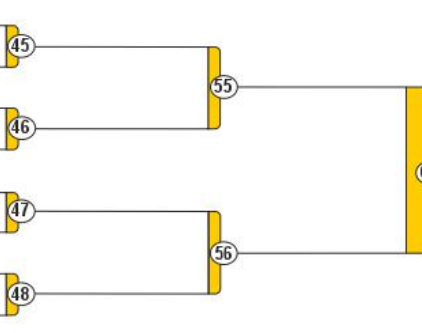

POOL D Winner / Ganador
Vainqueur / Sieger

1.

3.

3.

Trostrunde / Repechage / Ronda de consolación

Repechage

[A1]	
[A2]	61
[B1]	
[B2]	62
[C1]	
[C2]	63
[D1]	
[D2]	64

[A3]	
[A4]	65
[B3]	
[B4]	66
[C3]	
[C4]	67
[D3]	
[D4]	68

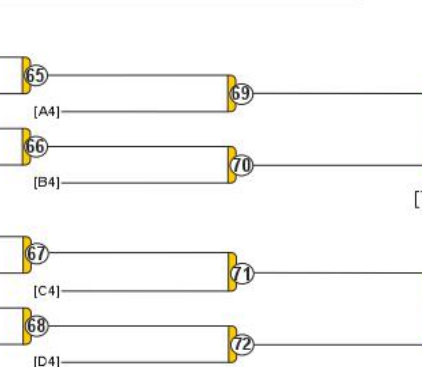

3.

3.

Results

Résultat / Platzierungen / Resultados

- 1.
- 2.
- 3.
- 3.
- 5.
- 5.
- 7.
- 7.

Copa de Espanya A Junior Ciudad de Valencia 2017

Valencia (ESP), 14 Oct 2017

-90 kg

12 Judoka

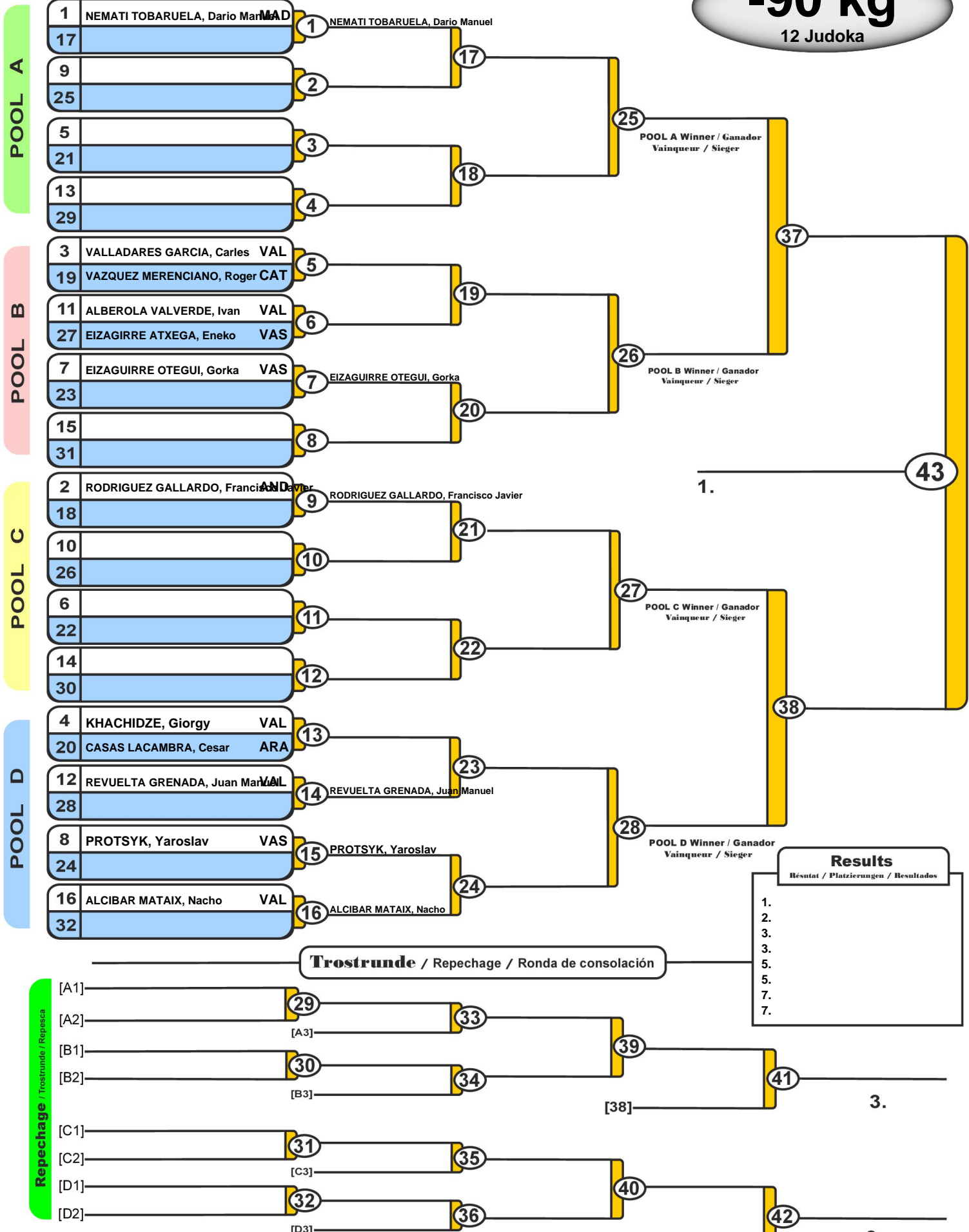

Copa de Espanya A Junior Ciudad de Valencia 2017

Valencia (ESP), 14 Oct 2017

-100 kg

7 Judoka

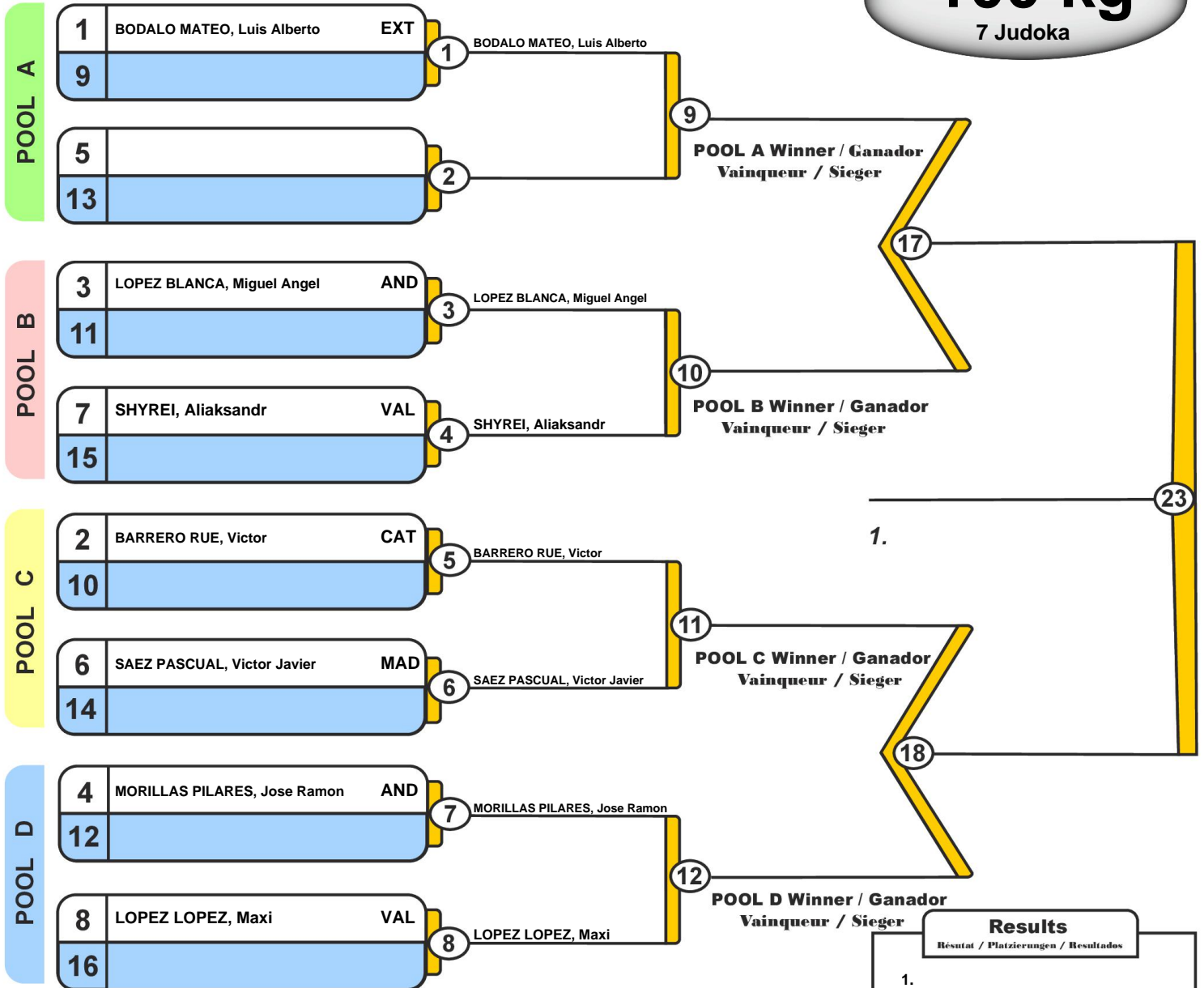

1.

18

Results	
Resultat / Platzierungen / Resultados	
1.	
2.	
3.	
3.	
5.	
7.	
7.	

Trostrunde / Repechage / Ronda de consolación

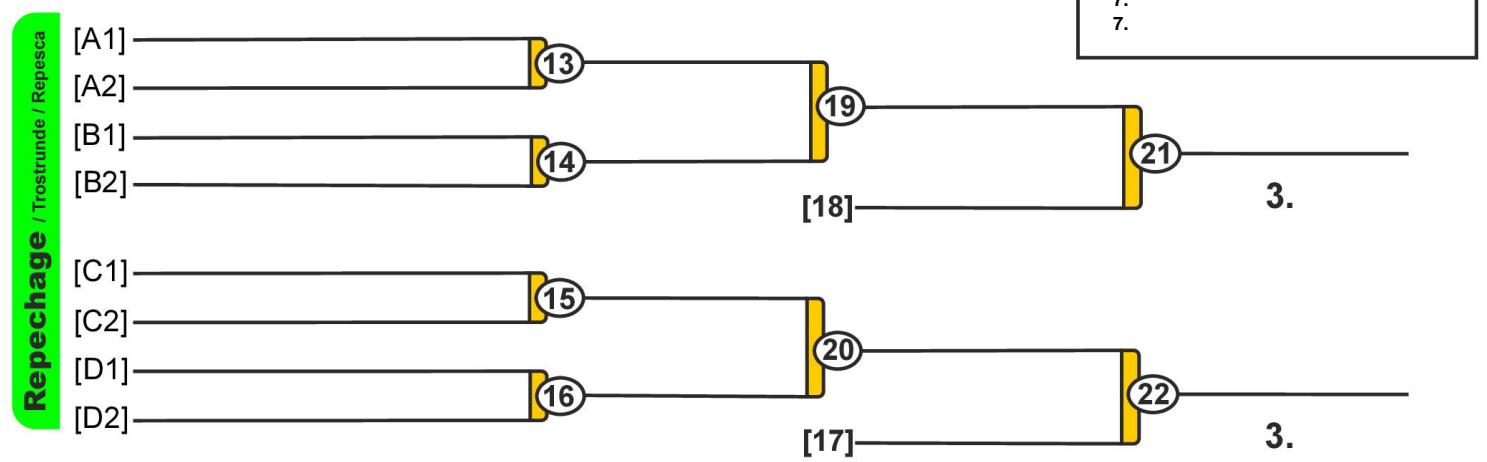

Copa de Espanya A Junior Ciudad de Valencia 2017

Valencia (ESP), 14 Oct 2017

-44 kg

4 Judoka

		1	2	3	4	
1	BARANDIARAN BARREIRO, Eid VAS					0 (0)
2	MARTINEZ MALO, Belen ARA					0 (0)
3	ROJAS GONZALEZ, Maria MAD					0 (0)
4	TORREGROSA PINA, Laura VAL					0 (0)

1	BARANDIARAN BARREIRO, Eid VAS	①
2	MARTINEZ MALO, Belen ARA	

3	ROJAS GONZALEZ, Maria MAD	②
4	TORREGROSA PINA, Laura VAL	

1	BARANDIARAN BARREIRO, Eid VAS	③
3	ROJAS GONZALEZ, Maria MAD	

2	MARTINEZ MALO, Belen ARA	④
4	TORREGROSA PINA, Laura VAL	

1	BARANDIARAN BARREIRO, Eid VAS	⑤
4	TORREGROSA PINA, Laura VAL	

2	MARTINEZ MALO, Belen ARA	⑥
3	ROJAS GONZALEZ, Maria MAD	

Final Results

- 1.
- 2.
- 3.



Copa de Espanya A Junior Ciudad de Valencia 2017

Valencia (ESP), 14 Oct 2017

-48 kg

9 Judoka

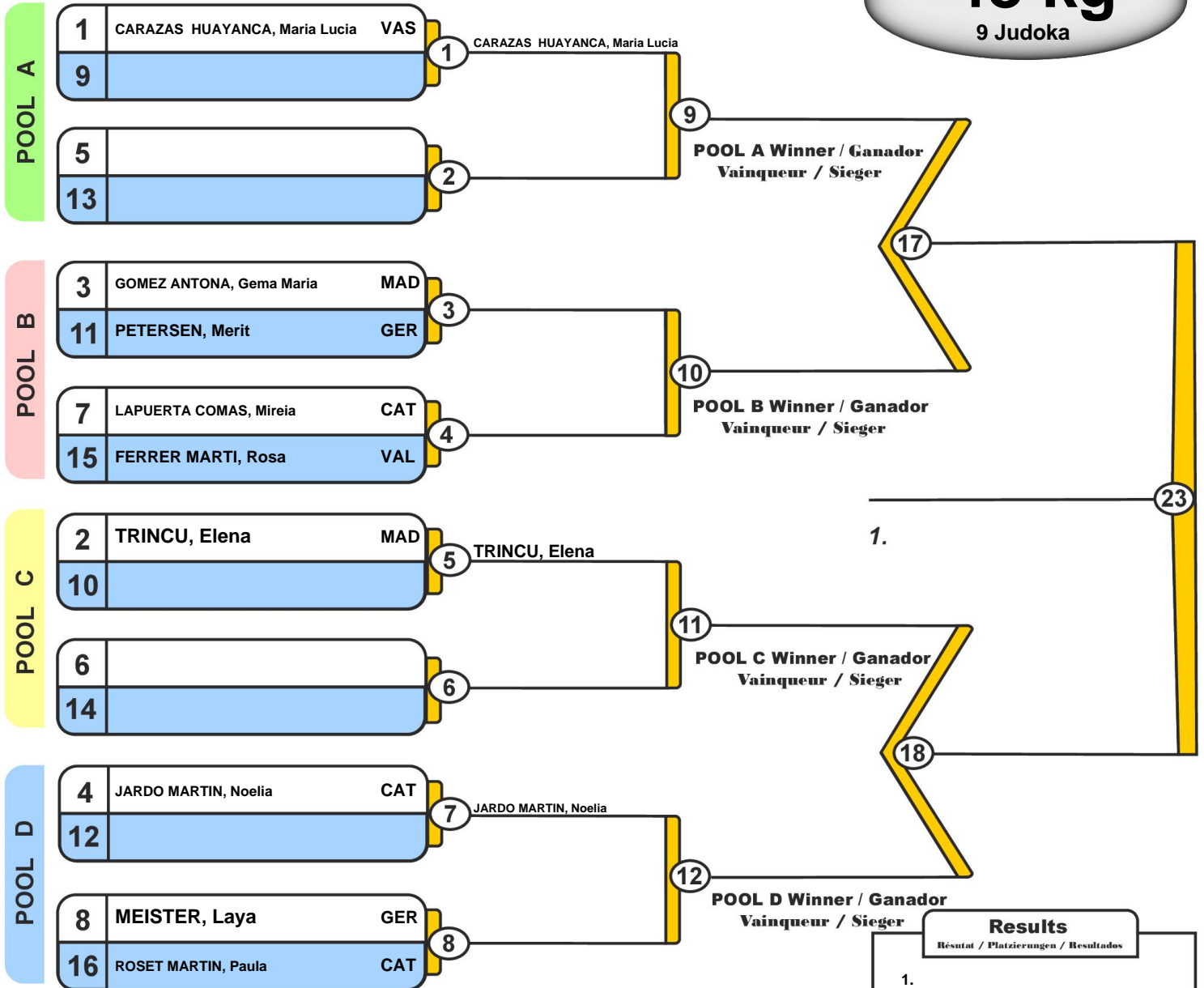

Trostrunde / Repechage / Ronda de consolación

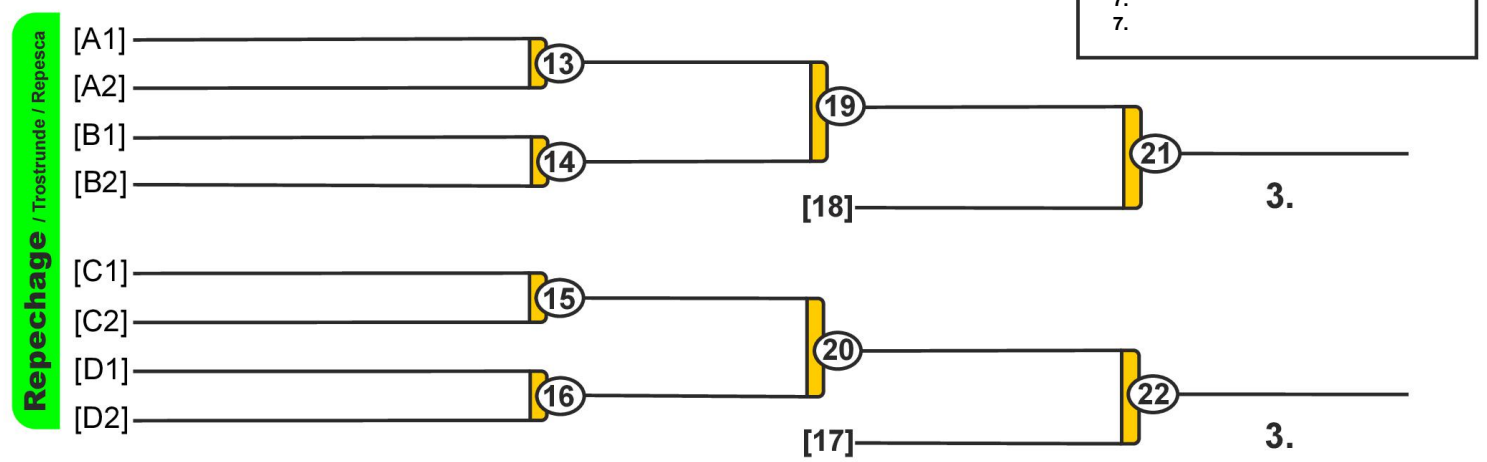

Results	
Resultat / Platzierungen / Resultados	
1.	
2.	
3.	
3.	
5.	
7.	
7.	

Copa de Espanya A Junior Ciudad de Valencia 2017

Valencia (ESP), 14 Oct 2017

-52 kg

14 Judoka

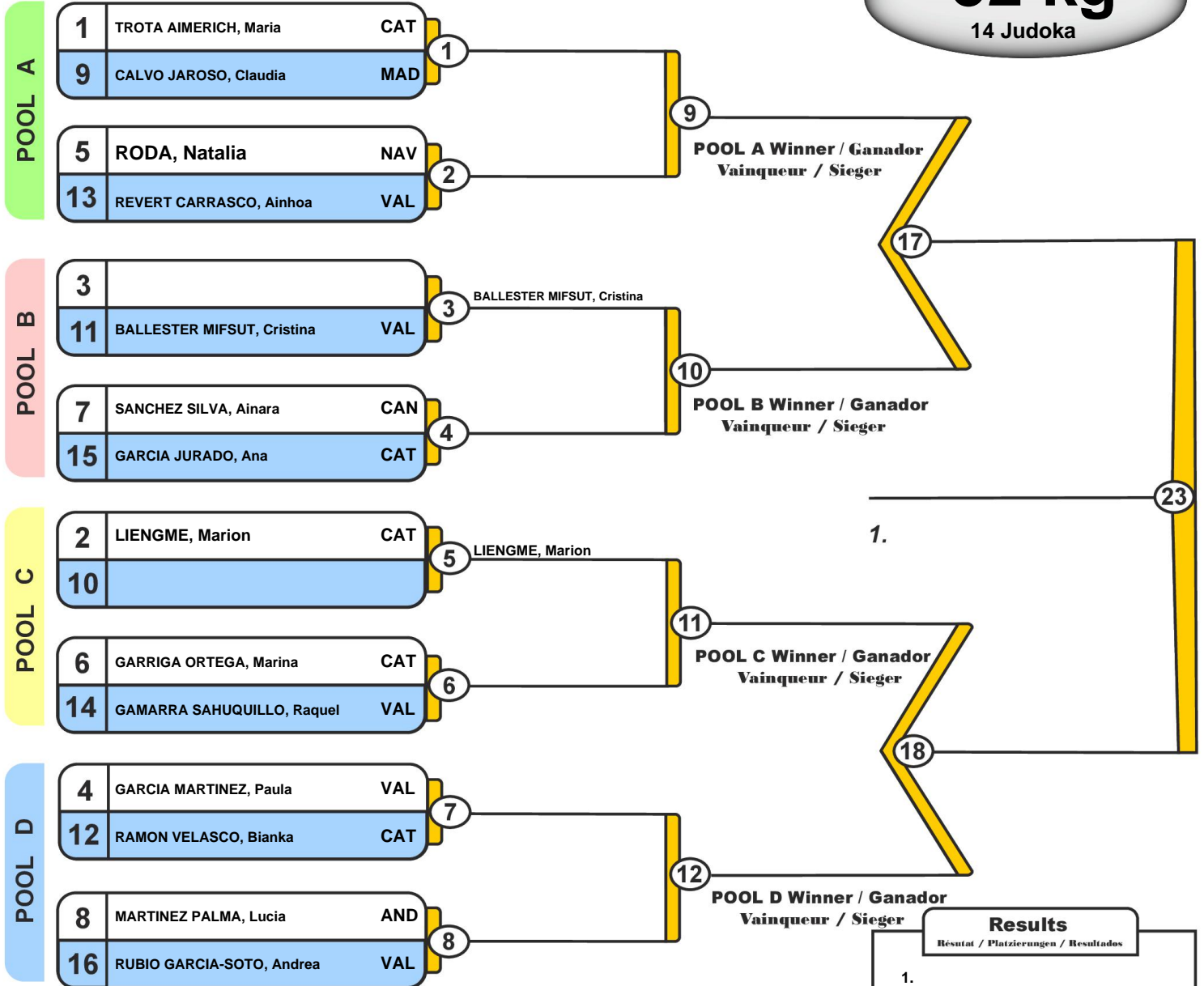

1.

18

- 1.
- 2.
- 3.
- 3.
- 5.
- 7.
- 7.

Trostrunde / Repechage / Ronda de consolación

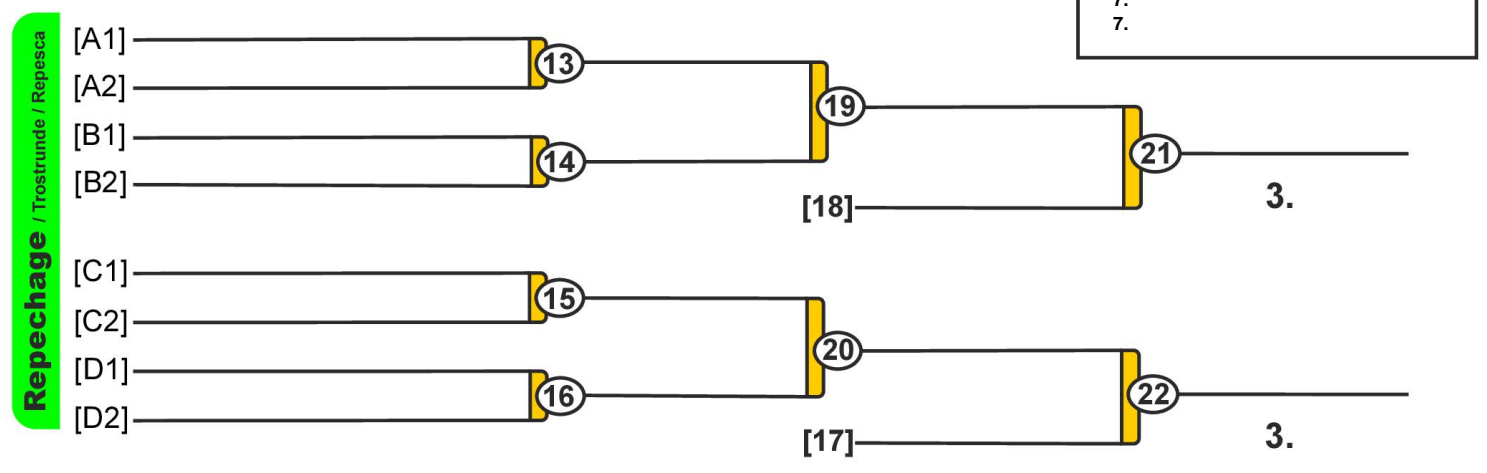

Copa de Espanya A Junior Ciudad de Valencia 2017

Valencia (ESP), 14 Oct 2017

-57 kg

10 Judoka

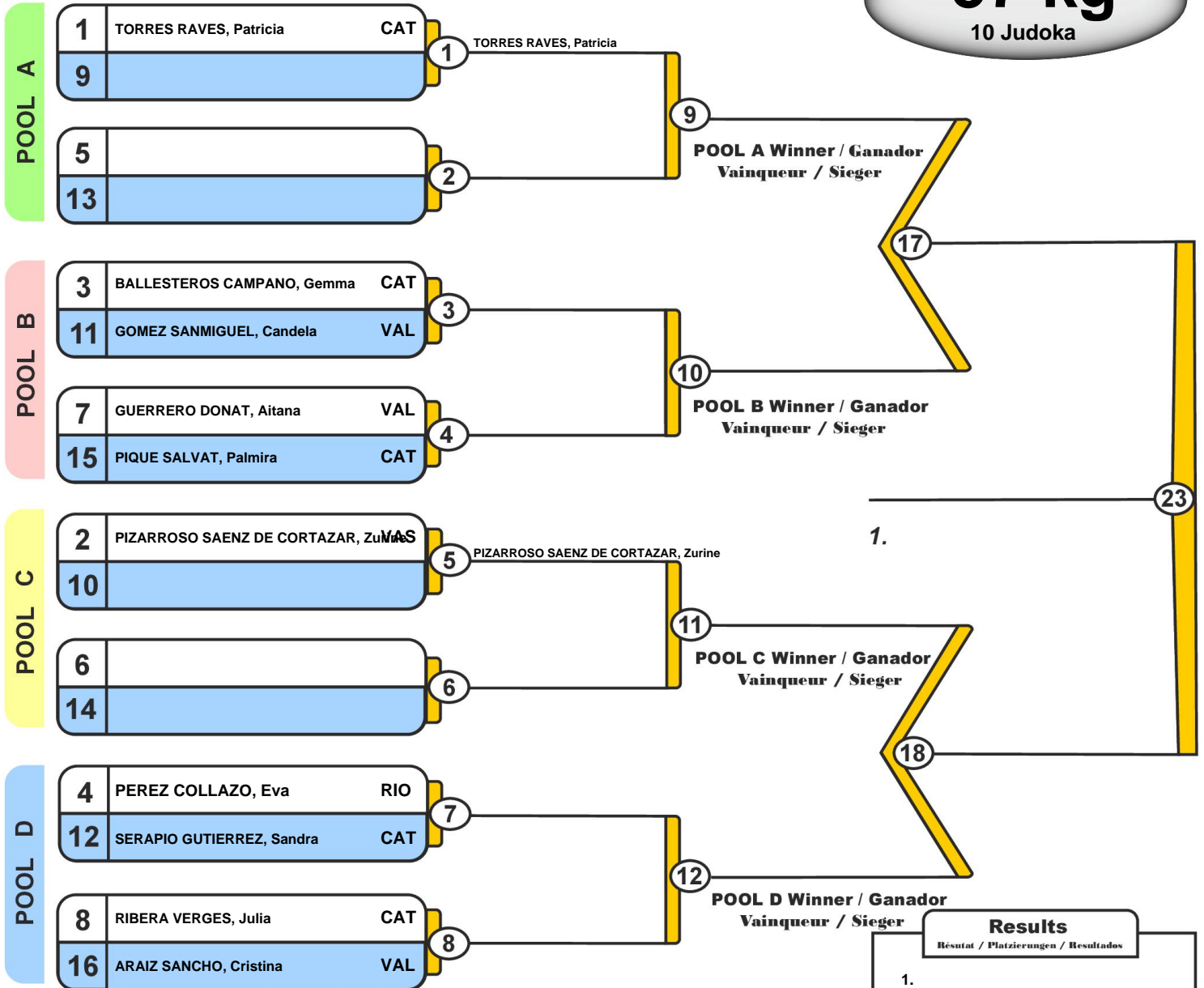

Trostrunde / Repechage / Ronda de consolación

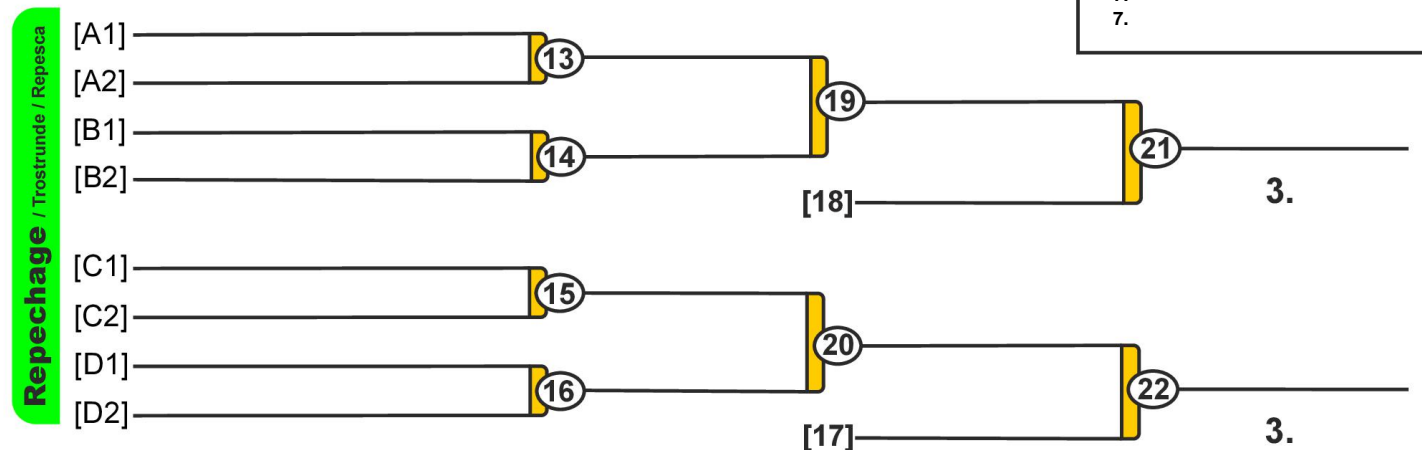

Results	
Resultat / Platzierungen / Resultados	
1.	
2.	
3.	
3.	
5.	
7.	
7.	

Copa de Espanya A Junior Ciudad de Valencia 2017

Valencia (ESP), 14 Oct 2017

-63 kg

9 Judoka

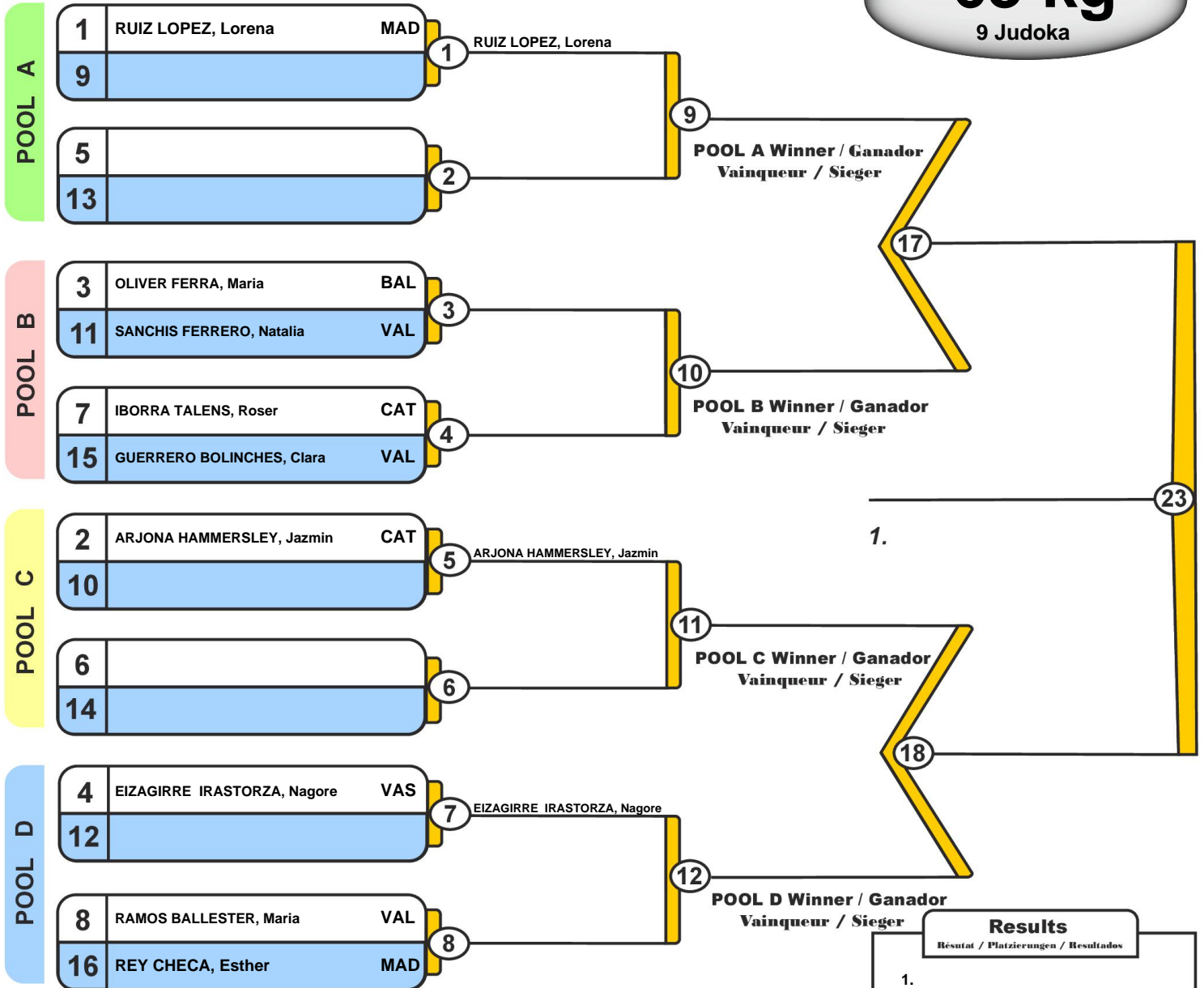

Trostrunde / Repechage / Ronda de consolación

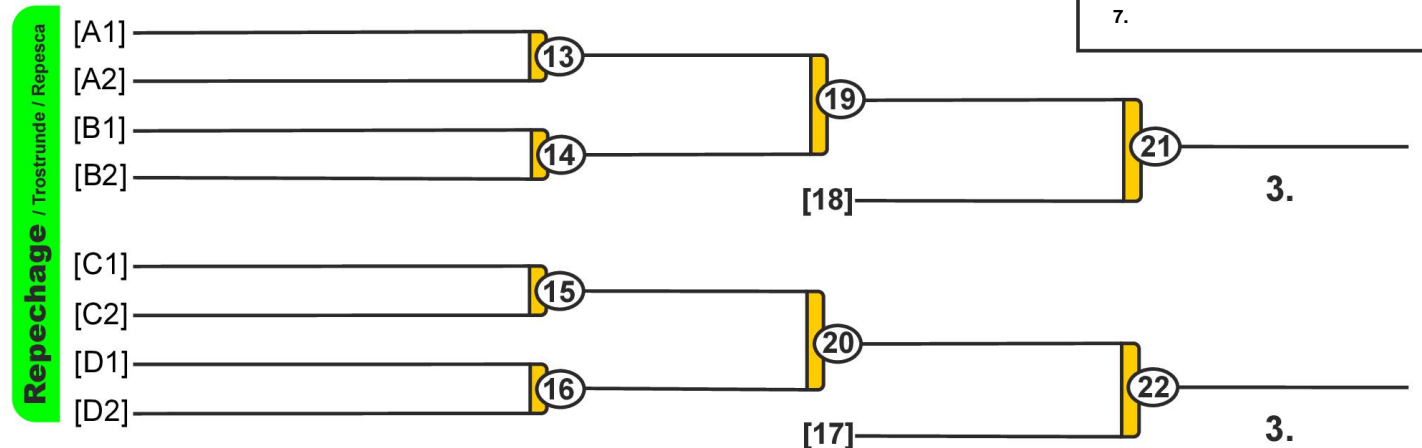

Results	
Resultat / Platzierungen / Resultados	
1.	
2.	
3.	
3.	
5.	
7.	
7.	

Copa de Espanya A Junior Ciudad de Valencia 2017

Valencia (ESP), 14 Oct 2017

-70 kg

10 Judoka

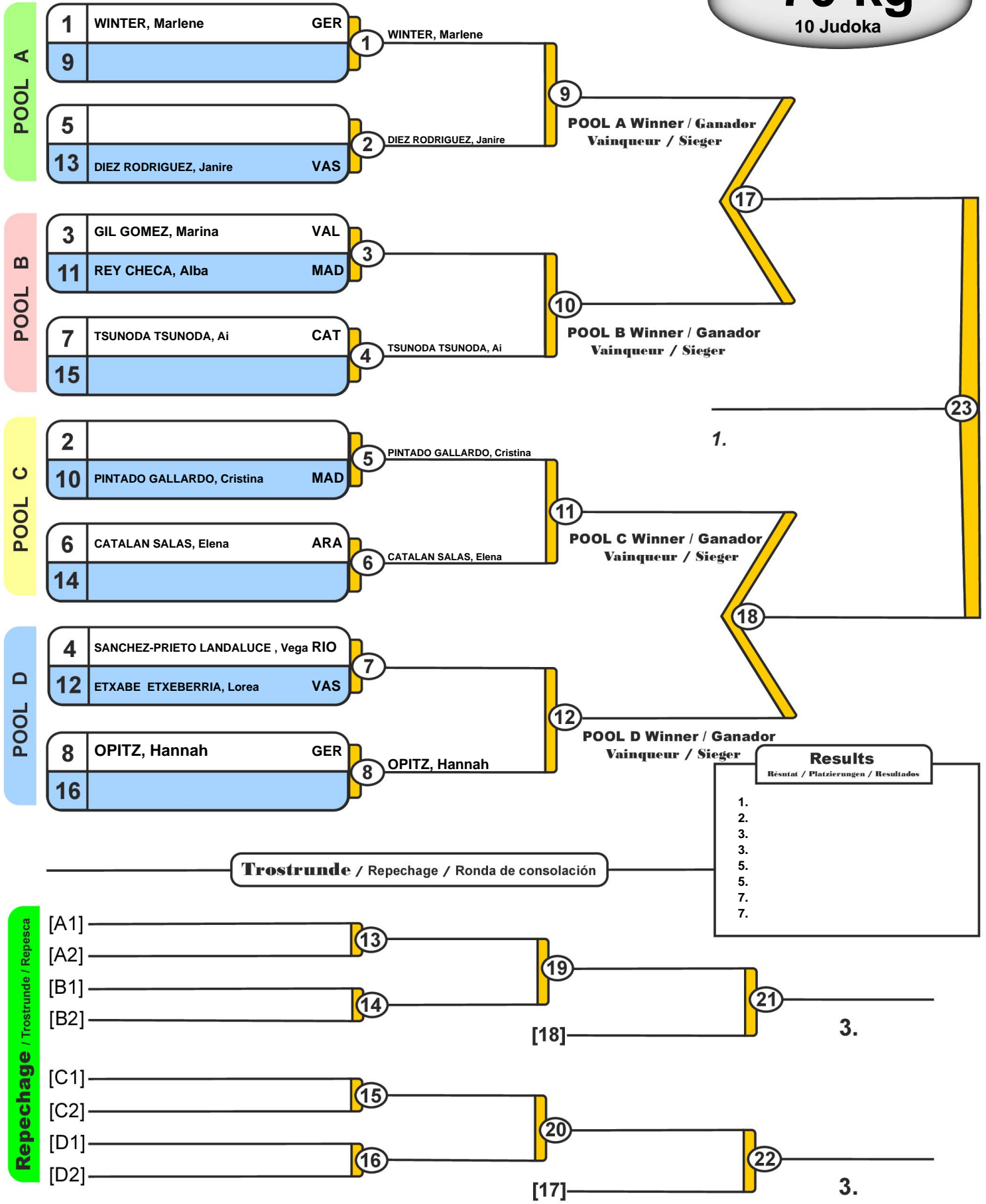

Copa de Espanya A Junior Ciudad de Valencia 2017

Valencia (ESP), 14 Oct 2017

-78 kg

3 Judoka

			1	2	3	Wins Score
1	SANSEBASTIAN SILVA, Beatriz	VAL				0 0
2	ELIZALDE BRIGANTE, Belen	VAL				0 0
3	PEREZ GOMEZ, Lucia	CLM				0 0

1	SANSEBASTIAN SILVA, Beatriz	VAL	①
2	ELIZALDE BRIGANTE, Belen	VAL	

1	SANSEBASTIAN SILVA, Beatriz	VAL	②
3	PEREZ GOMEZ, Lucia	CLM	

2	ELIZALDE BRIGANTE, Belen	VAL	③
3	PEREZ GOMEZ, Lucia	CLM	

Final Results

- 1.
- 2.
- 3.

Copa de Espanya A Junior Ciudad de Valencia 2017

Valencia (ESP), 14 Oct 2017

+78 kg

3 Judoka

			1	2	3	Wins Score
1	FERNANDEZ VAYA, Eva	VAL				0 0
2	FABER, Christina	GER				0 0
3	FERRER BARTULOS, Patricia	ARA				0 0

1	FERNANDEZ VAYA, Eva	VAL	①
2	FABER, Christina	GER	

1	FERNANDEZ VAYA, Eva	VAL	②
3	FERRER BARTULOS, Patricia	ARA	

2	FABER, Christina	GER	③
3	FERRER BARTULOS, Patricia	ARA	

Final Results

- 1.
- 2.
- 3.